

Nova Rainscreen System

Horizontal Installation

Nova's QuickClip Rainscreen Siding System is engineered to withstand the test of time. Hewn has chosen this glass-infused nylon rainscreen clip for its high quality and consistency. Rainscreen applications are a beautiful way to clad an exterior wall, making it less likely to suffer moisture problems that lead to rot and warping. These clips also allow for hidden fastening installation, facilitating a modern and clean aesthetic.

Installation

Materials Needed

- Cor-A-Vent Siding Vent (3" or 4" wide)
- GRK R4 screw #9x2" or longer
- Cordless drill
- End seal
- Weather Resistive Barrier-House Wrap or Tyvek Equivalent Level
- Angle grinder
- Rubber mallet
- Chalk line
- Furring strips (just a few for finishing purposes)

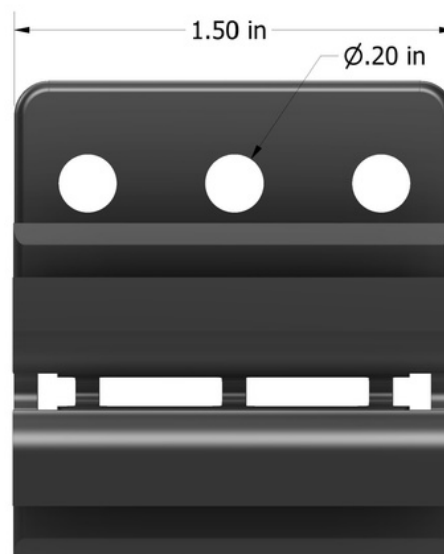
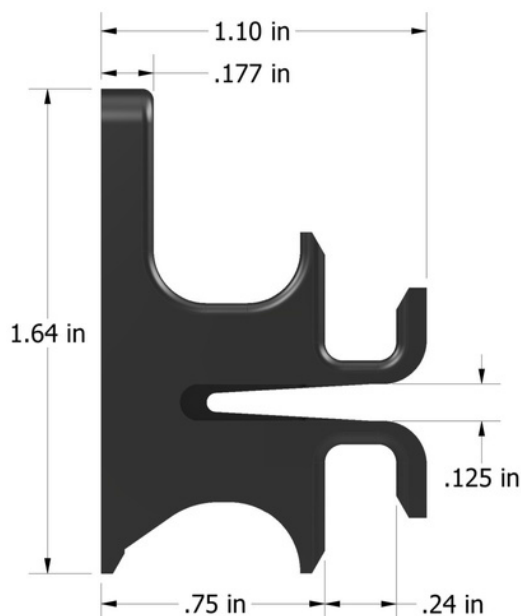

Nova Rainscreen System

Horizontal Installation

Prior To Installation

- Calculate how much siding you will need based on the "Net Finished Dimensions" only.
- Hewn Rainscreen Siding must acclimate to your local climate.
- Use End Seal to cover the end of the grain of any freshly cut siding boards.

Step-by-Step Installation Guide

Step 1: Install house wrap over Plywood sheathing to prevent moisture intrusion. (Always follow the vapor barrier manufacturer's instructions.)

Step 2: Using a chalk line, mark a level horizontal line at the point where the base of the Rainscreen siding will align. This is your baseline. It is recommended your first board sits a minimum of 6" above the ground.

Step 3: Using a chalk line, mark where your studs are located for ease of installation.

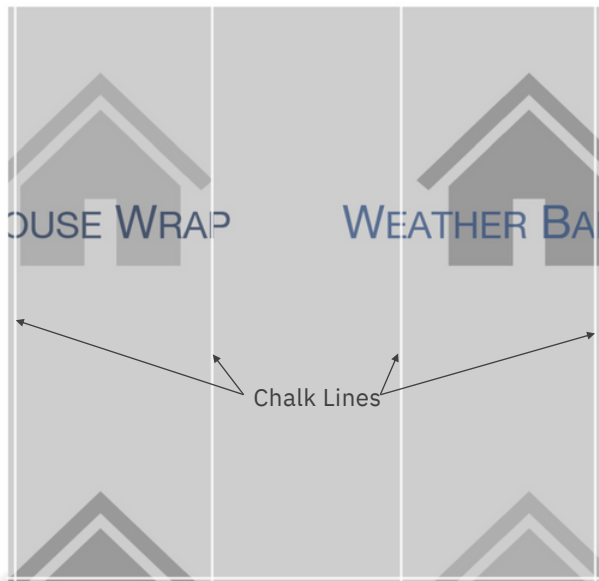
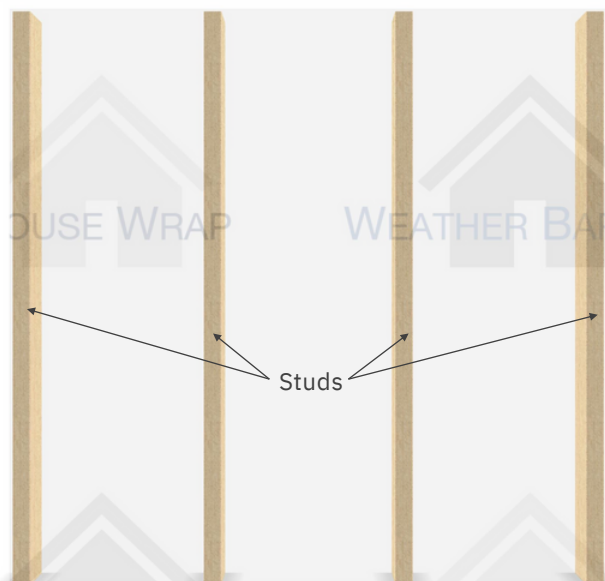

Nova Rainscreen System

Horizontal Installation

Step 4: Install your first series of clips on your baseline, screwing through the Vapor Barrier to the stud. You may wish to cut the clip (an angle grinder will work) to eliminate the bottom part which will not be supporting anything).

Step 5: Align each starter clip with the studs you marked. Make sure that the clips are level and evenly spaced on the studs. You may need 2 screws for each clip for the first course of clips.

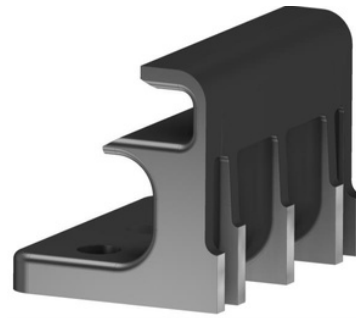

Step 6: Cut strips of Cor-A-Vent and screw into the vapor barrier/sheathing horizontally so that it fills the space between the clips. The Cor-A-Vent should run along the baseline behind your siding to permit airflow and to eliminate pests.

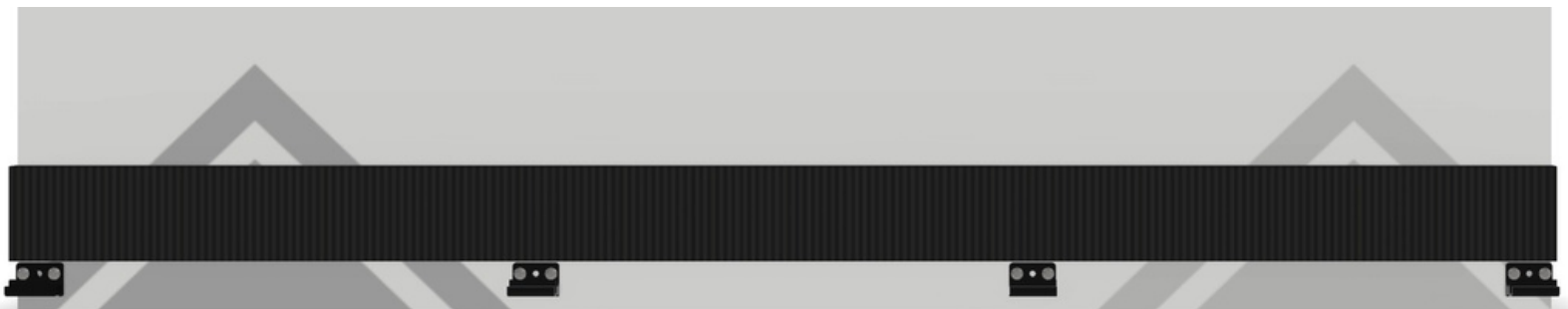

Nova Rainscreen System

Horizontal Installation

Step 7: Install the first Hewn Rainscreen Siding board on top of the starter clips.

TIP: Use a level to ensure this first board is aligned properly)

Step 8: Fit the next course of clips over the first row of Hewn Rainscreen siding boards. Ensure that the edges are engaged – use a rubber mallet CAREFULLY to align boards properly.

Step 9: Once the clips are engaged, connect the second set of clips, driving one or two screws through the siding fastener into the stud. Ensure that the clips are level, and continue to check level throughout the installation.

Step 10: Set the proceeding Hewn Rainscreen siding boards on top of the installed siding fasteners. Continue to install clips and Hewn Rainscreen boards until you have reached the top of your installation area. Clips will usually require only one screw at this point of installation.

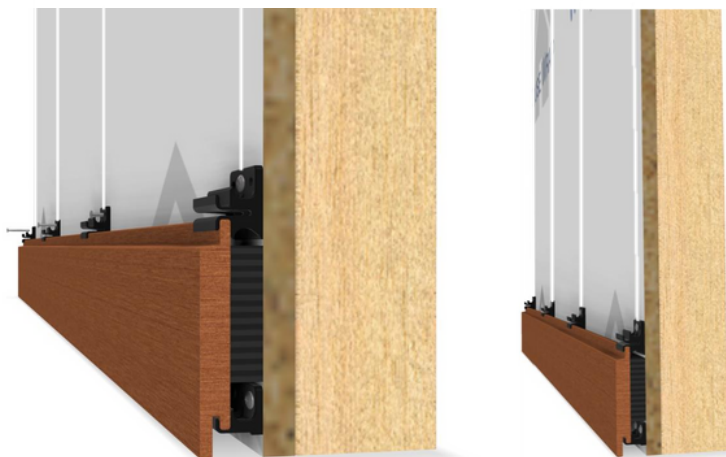
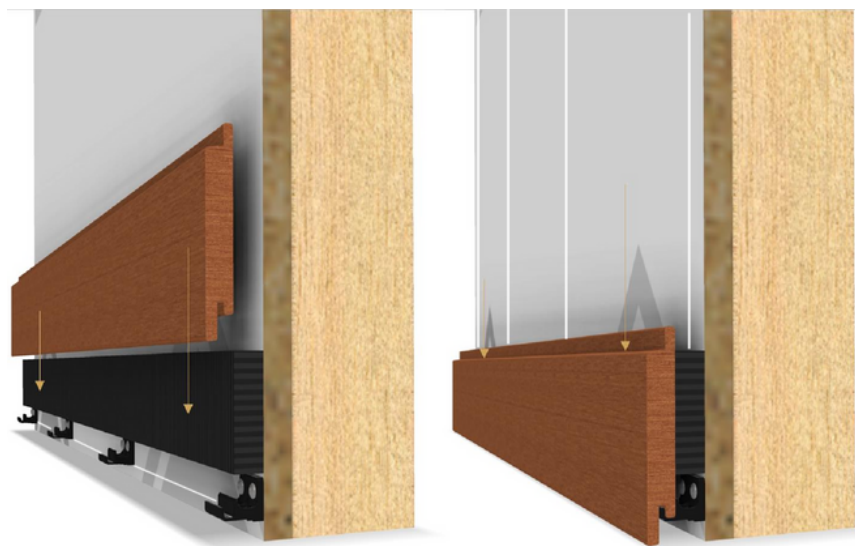

Nova Rainscreen System

Horizontal Installation

Step 11: When using multiple boards to span the length of the wall, ensure that the rainscreen boards butt together properly. The boards should meet in the middle of the stud, with a single clip centered between the two boards.

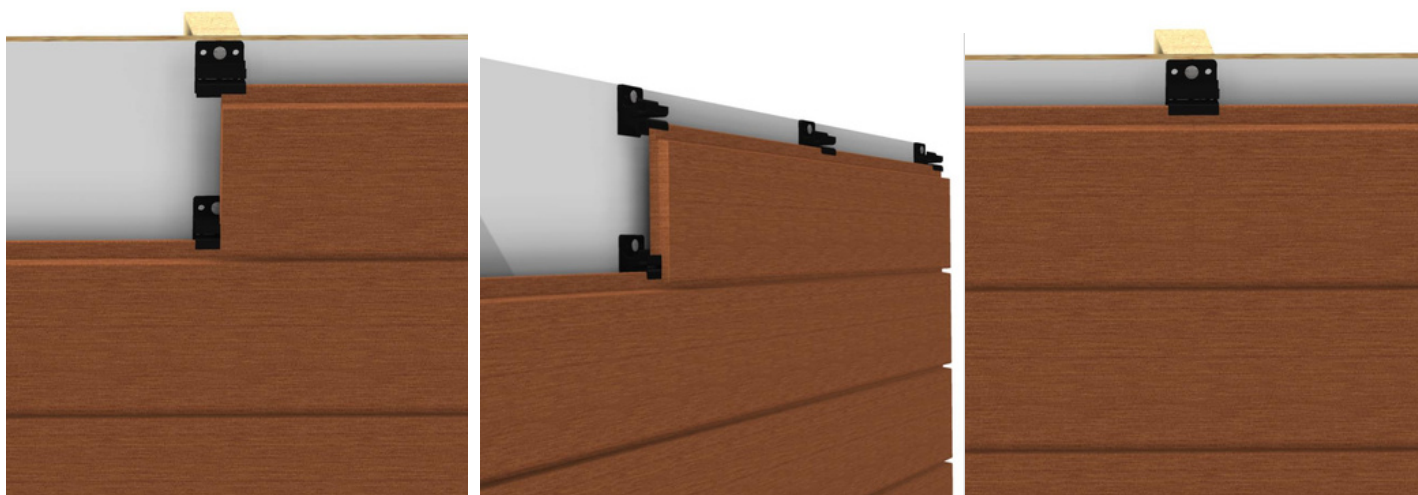

Step 12: When you are ready to install your last complete board, screw another course of Cor-A-Vent behind the board. The Cor-A-Vent will sit between your last two rows of clips.

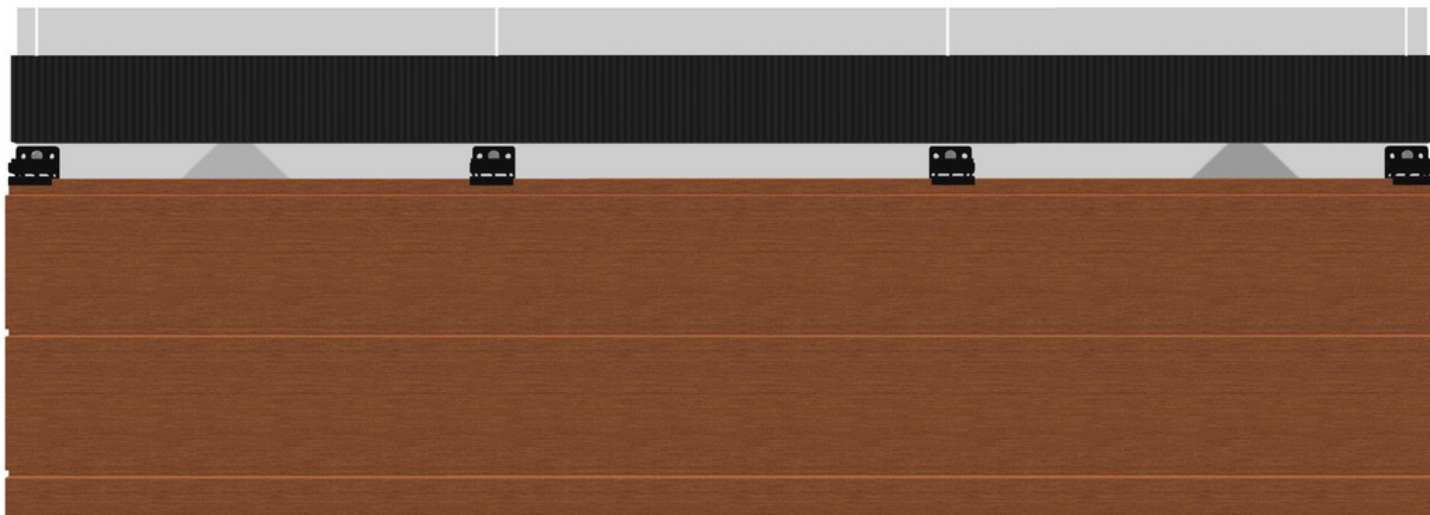

Nova Rainscreen System

Horizontal Installation

Step 13: To install your final board, first measure the remaining span that needs covered. Trim (rip) your rainscreen board to the appropriate width. Make sure you are trimming the correct side of the board off and leaving the correct side intact to fit into the clips.

Step 14: Fasten a 1 x 2 furring strip across the length of the wall through the particle board and into the framing.

Step 15: Insert the adjusted board into the last row of clips. Fasten the rainscreen board to the furring strips.

Allowable Movement

When installing Hewn Rainscreen Siding, install each board as tightly as possible to leave the smallest gaps between them in case shrinkage occurs. Do not attempt to bend the Nova QuickClips – they will move on their own to accommodate the movement of the wood. The clip accommodates up to 1/8" of expansion or swelling. Shrinkage and swelling vary depending on climate and exposure to moisture. The Nova QuickClip Rainscreen Siding System is the only resilient clip on the market and will allow for the natural movement of the wood.

End Sealing

Fresh cuts should be sealed within 24hrs with end grain sealant. End grain sealant is shipped with your siding. The end grain sealant is simply applied with a paintbrush.

Support

Please reach out to maintenance@hewn.com with any questions or concerns regarding your Hewn Rainscreen Siding.

