

# Nova Rainscreen System

## Vertical Installation · Horizontal Trim Board

Nova's QuickClip Rainscreen Siding System is engineered to withstand the test of time. Hewn has chosen this glass-infused nylon rainscreen clip for its high quality and consistency. Rainscreen applications are a beautiful way to clad an exterior wall, making it less likely to suffer moisture problems that lead to rot and warping. These clips also allow for hidden fastening installation, facilitating a modern and clean aesthetic.

### Installation

#### Materials Needed

- Cor-A-Vent Siding Vent (3" or 4" wide)
- GRK R4 screw #9x2" or longer
- Cordless drill
- End seal
- Weather Resistive Barrier-House Wrap or Tyvek Equivalent Level
- Angle grinder
- Rubber mallet
- Chalk line
- Furring strips (just a few for finishing purposes)

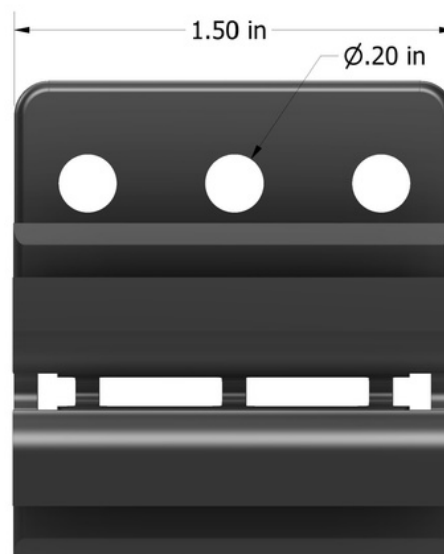
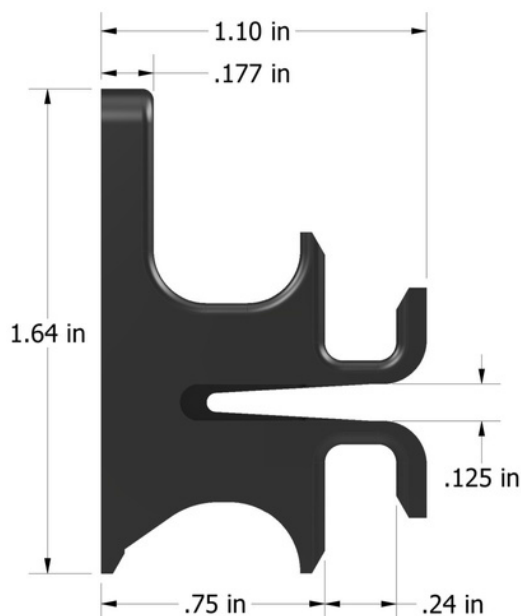

# Nova Rainscreen System

## Vertical Installation · Horizontal Trim Board

### Prior To Installation

- Calculate how much siding you will need based on the "Net Finished Dimensions" only.
- Hewn Rainscreen Siding must acclimate to your local climate.
- Use End Seal to cover the end of the grain of any freshly cut siding boards.

### Step-by-Step Installation Guide

#### Horizontal Trim Board Method

**IMPORTANT:** Ensure that your sheathing is rated for structural use and installed according the manufactures guidelines and local building codes. Structural sheathing is the only safe way to install vertical rainscreen without adding additional framing or use of furring strips.

**Step 1:** Install house wrap over Plywood sheathing to prevent moisture intrusion. (Always follow the vapor barrier manufacturer's instructions.)

**Step 2:** Using a chalk line, mark a level horizontal line at the point where the base of the Rainscreen siding will align. This is your baseline. It is recommended your first board sits a minimum of 6" above the ground.

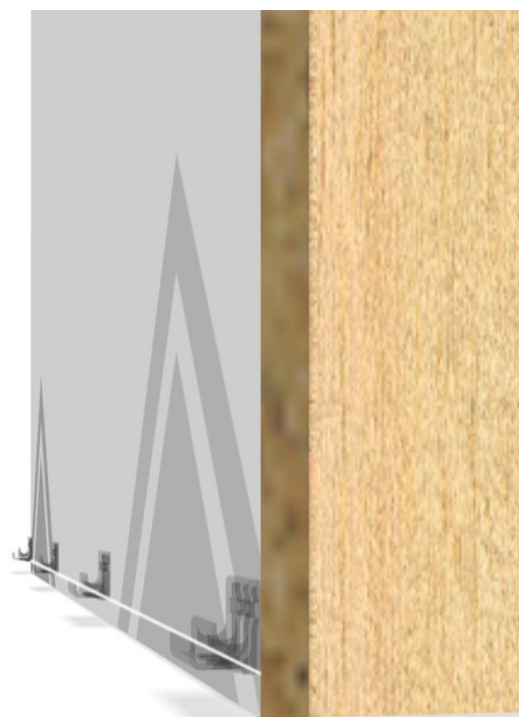

# Nova Rainscreen System

## Vertical Installation · Horizontal Trim Board

**Step 3:** Using a chalk line, mark where your studs are located for ease of installation.

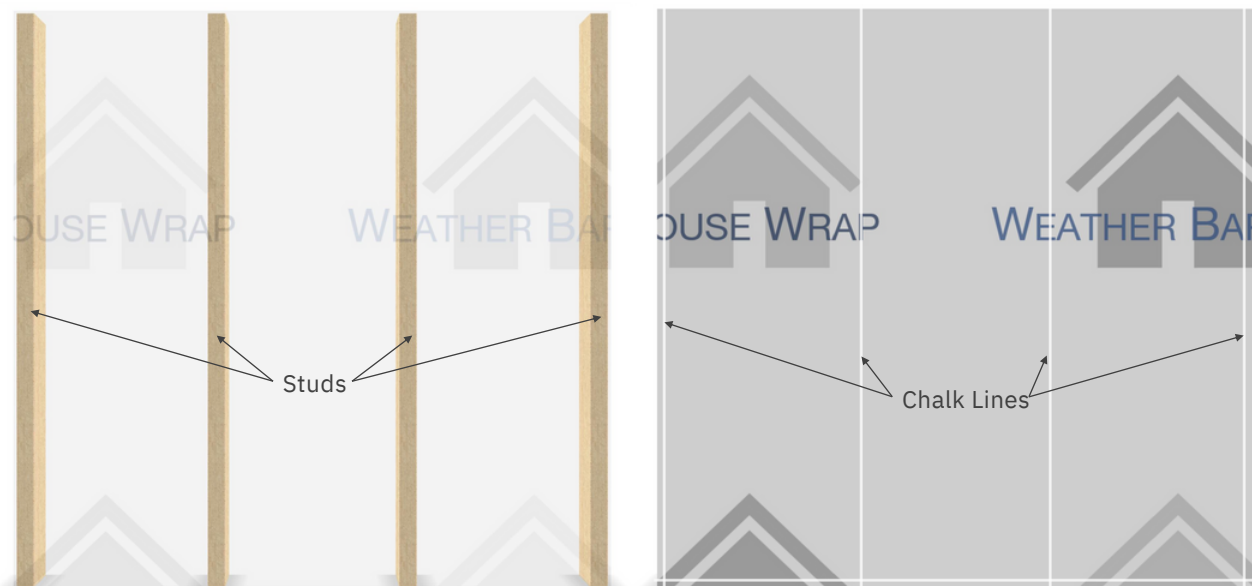

**Step 4:** Install your first series of clips on your baseline, screwing through the Vapor Barrier to the stud. You may wish to cut the clip (an angle grinder will work) to eliminate the bottom part which will not be supporting anything).

**Step 5:** Align each starter clip with the studs you marked. Make sure that the clips are level and evenly spaced on the studs. You may need 2 screws for each clip for the first course of clips.





# Nova Rainscreen System

## Vertical Installation · Horizontal Trim Board

**Step 6:** Rip/trim the top groove off of however many rainscreen boards are needed to cover the length of the wall.

**Step 7:** Obtain enough length of 1 x 2" furring strips to cover the entire length of the wall. Cut small vertical channels (weep holes) into the furring strip approximately 12 inches apart. These are required to allow for drainage through the furring strip. These channels will face the wall.

**Step 8:** Fasten the furring strip across the length of the wall above the installed starter clips to the appropriate height that matches the width of the trim board. Ensure the furring strip is installed into the framing.

Discarded End

Cut

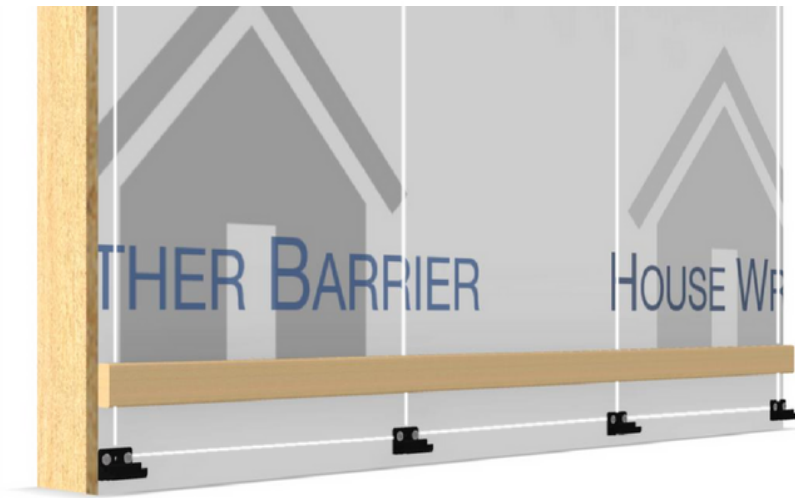
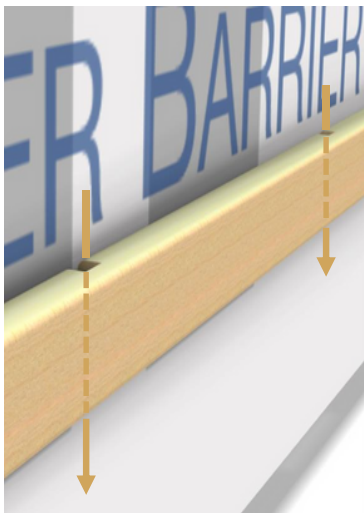

**Step 9:** Insert the trimmed rainscreen board into the row of starter clips. Gently tap board with rubber mallet if need to insert the board fully into the clips.



# Nova Rainscreen System

## Vertical Installation · Horizontal Trim Board

**Step 10:** Fasten the rainscreen board to the furring strips. You will need to pre-drill the rainscreen board in order to face screw and avoid any splitting. We recommend using a screw and plug system for a seamless look.

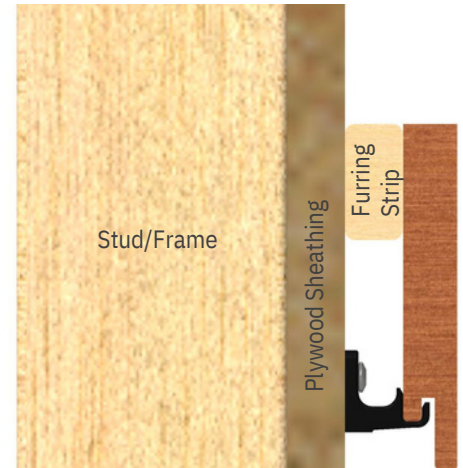

**Step 11:** Create horizontal chalk lines marking every 16 inches. These are the lines where your clips will be placed.

**Step 12:** Fasten your first column of clips. Depending on the wall you are building on, you may wish to cut the clip like from **Step 4**, to eliminate the side of the clip that would be on the outside.

**Step 13:** Install Cor-A-Vent appropriately at the top and bottom of your wall across the entire width.

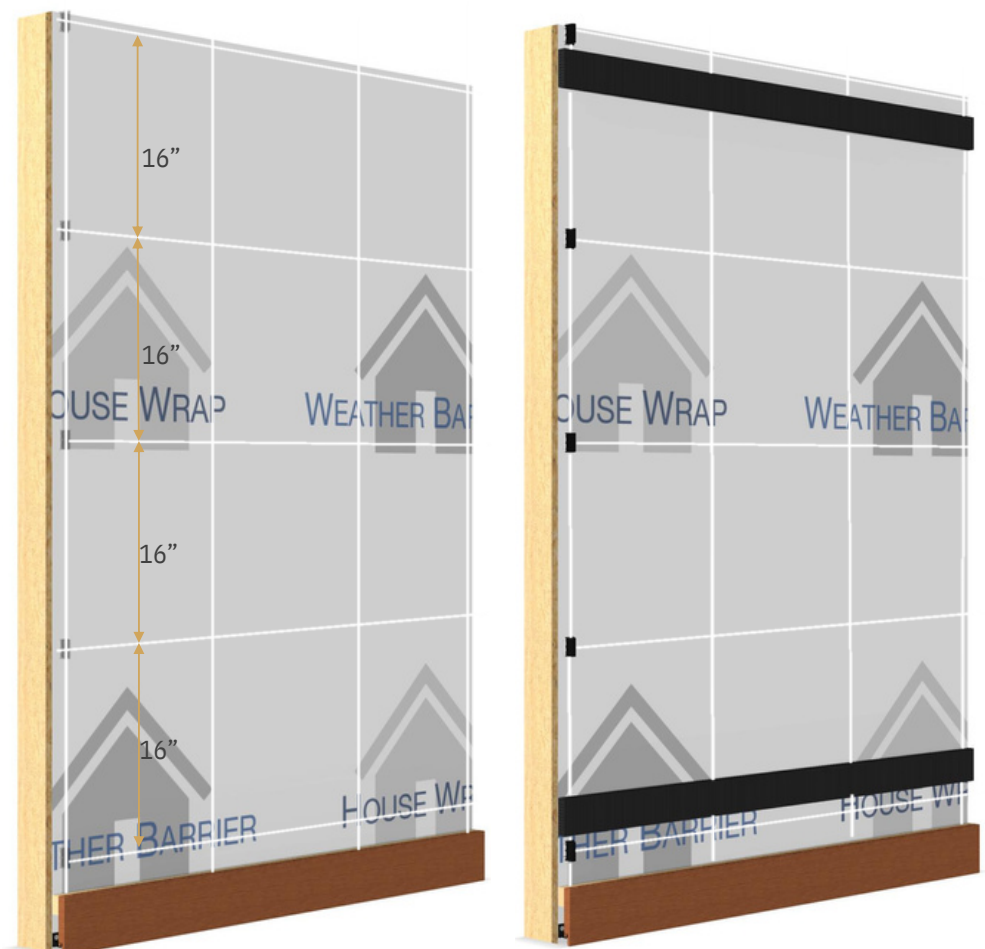



# Nova Rainscreen System

## Vertical Installation · Horizontal Trim Board

**Step 7:** Install the first Hewn Rainscreen Siding board on top of the starter clips.

**TIP: Use a level to ensure this first board is aligned properly)**

**Step 8:** Fit the next course of clips over the first row of Hewn Rainscreen siding boards. Ensure that the edges are engaged – use a rubber mallet CAREFULLY to align boards properly.

**Step 9:** Once the clips are engaged, connect the second set of clips, driving one or two screws through the siding fastener into the stud. Ensure that the clips are level, and continue to check level throughout the installation.

**Step 10:** Set the proceeding Hewn Rainscreen siding boards on top of the installed siding fasteners. Continue to install clips and Hewn Rainscreen boards until you have reached the top of your installation area. Clips will usually require only one screw at this point of installation.

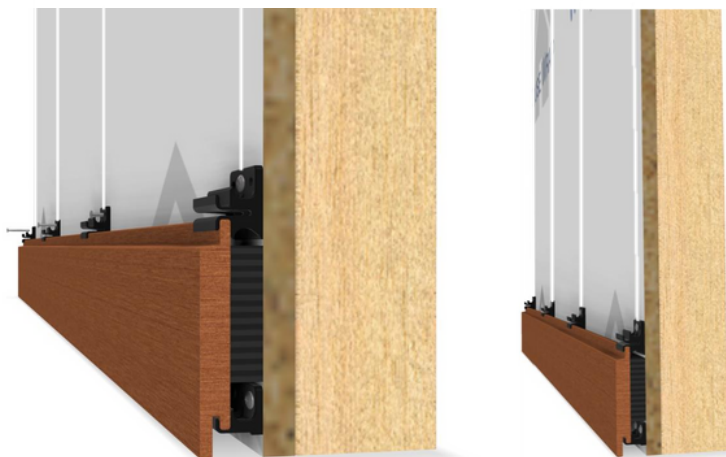
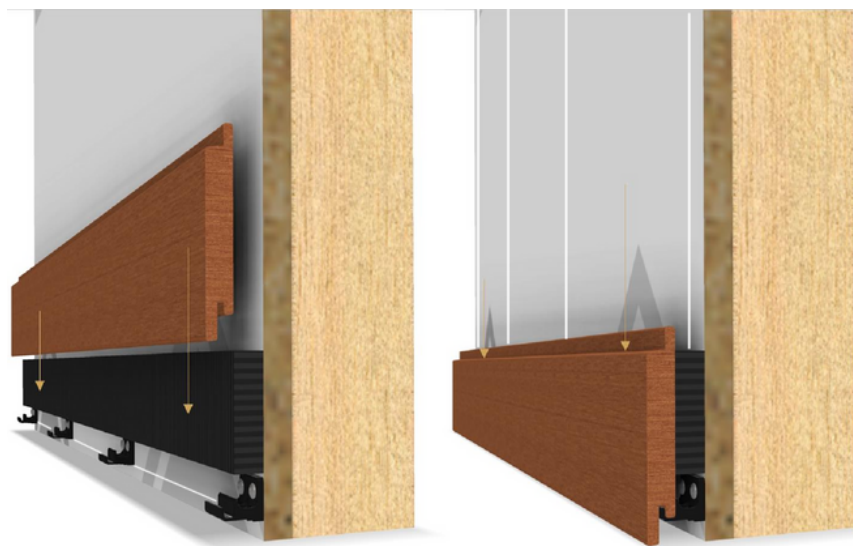

# Nova Rainscreen System

## Vertical Installation · Horizontal Trim Board

**Step 14:** Insert your first vertical board into the column of clips, gently tapping with rubber mallet if necessary.

**TIP:** Use a level to ensure this first board is aligned properly.

**Step 15:** Fasten your next column of clips using 1-2 screws on each clip and ensuring that they are lined up on your horizontal chalk lines.

**Step 16:** Continue to install clips and Rainscreen boards until you have covered the span of your installation area. Clips will usually require only one screw each at this point of installation.

**Step 17:** When using multiple boards to span the height of the wall, ensure that the rainscreen boards butt together properly. The boards should meet with a single clip centered between the two boards.

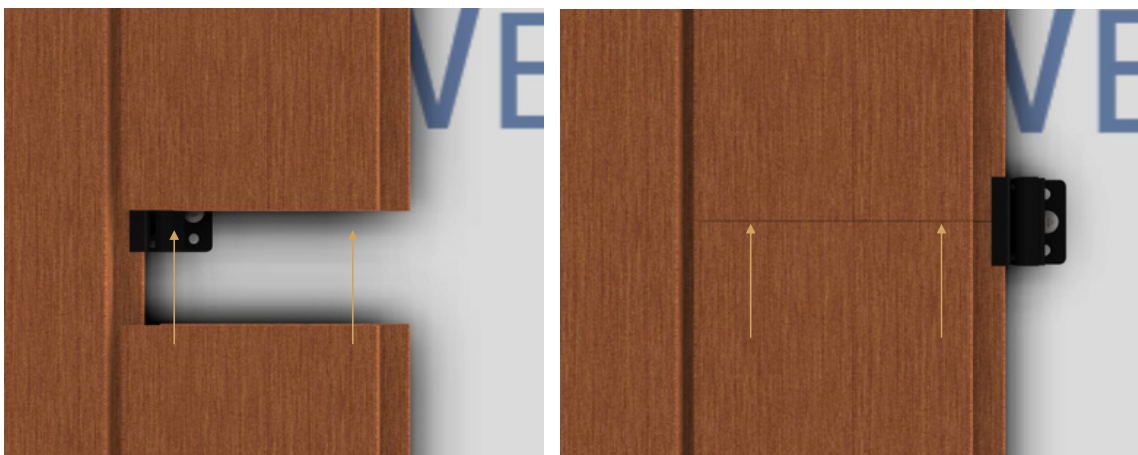



# Nova Rainscreen System

## Vertical Installation · Horizontal Trim Board

**Step 18:** To install your final board, first measure the remaining span that needs covered. Trim (rip) your rainscreen board to the appropriate width. Make sure you are trimming the correct side of the board off and leaving the correct side intact to fit into the clips.

**Step 19:** Fasten a 1 x 2 furring strip up the height the length of the wall through the particle board and into the framing.

**Step 20:** Insert the adjusted board into the last column of clips. Fasten the rainscreen board to the furring strips.

### Allowable Movement

When installing Hewn Rainscreen Siding, install each board as tightly as possible to leave the smallest gaps between them in case shrinkage occurs. Do not attempt to bend the Nova QuickClips – they will move on their own to accommodate the movement of the wood. The clip accommodates up to 1/8" of expansion or swelling. Shrinkage and swelling vary depending on climate and exposure to moisture. The Nova QuickClip Rainscreen Siding System is the only resilient clip on the market and will allow for the natural movement of the wood.

### End Sealing

Fresh cuts should be sealed within 24hrs with end grain sealant. End grain sealant is shipped with your siding. The end grain sealant is simply applied with a paintbrush.

### Support

Please reach out to [maintenance@hewn.com](mailto:maintenance@hewn.com) with any questions or concerns regarding your Hewn Rainscreen Siding.

